

Forme · Formes · Shapes · Formen · Formas

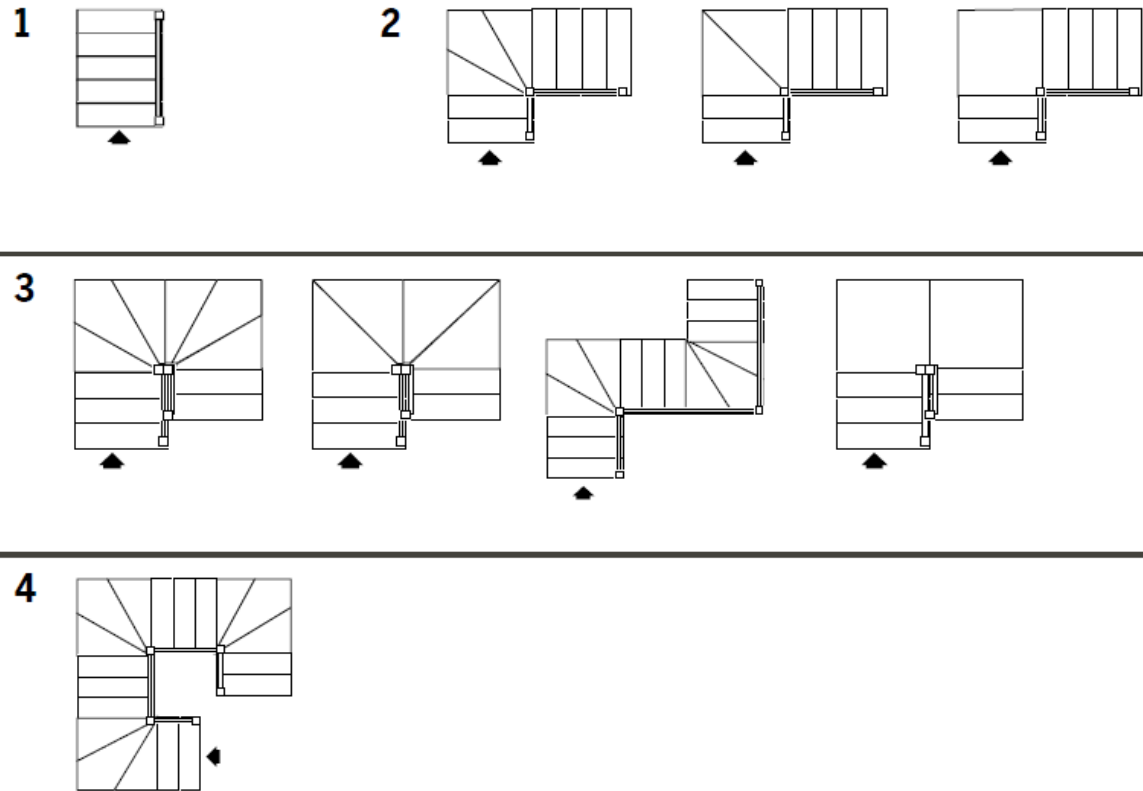

G10	G10	G11	G12	G13	G14	G15	G16	G17
	h	h	h	h	h	h	h	h
	1870	2040	2210	2380	2550	2720	2890	3060
	2310	2520	2730	2940	3150	3360	3570	3780

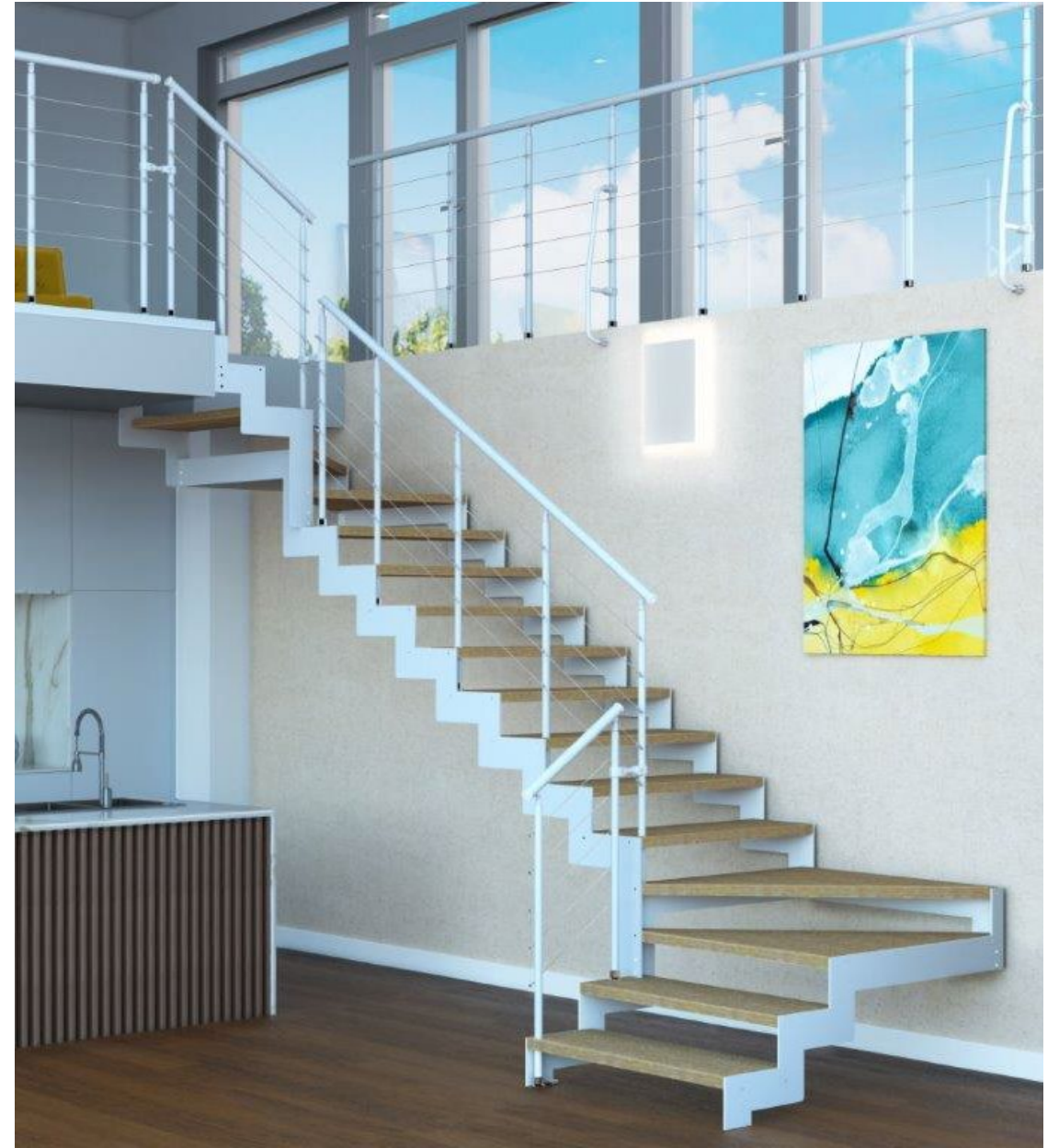

LE FORME DELLA STRUTTURA

The shapes of the structure

Les formes de la structure

Die Formen der Struktur

Las formas de la estructura

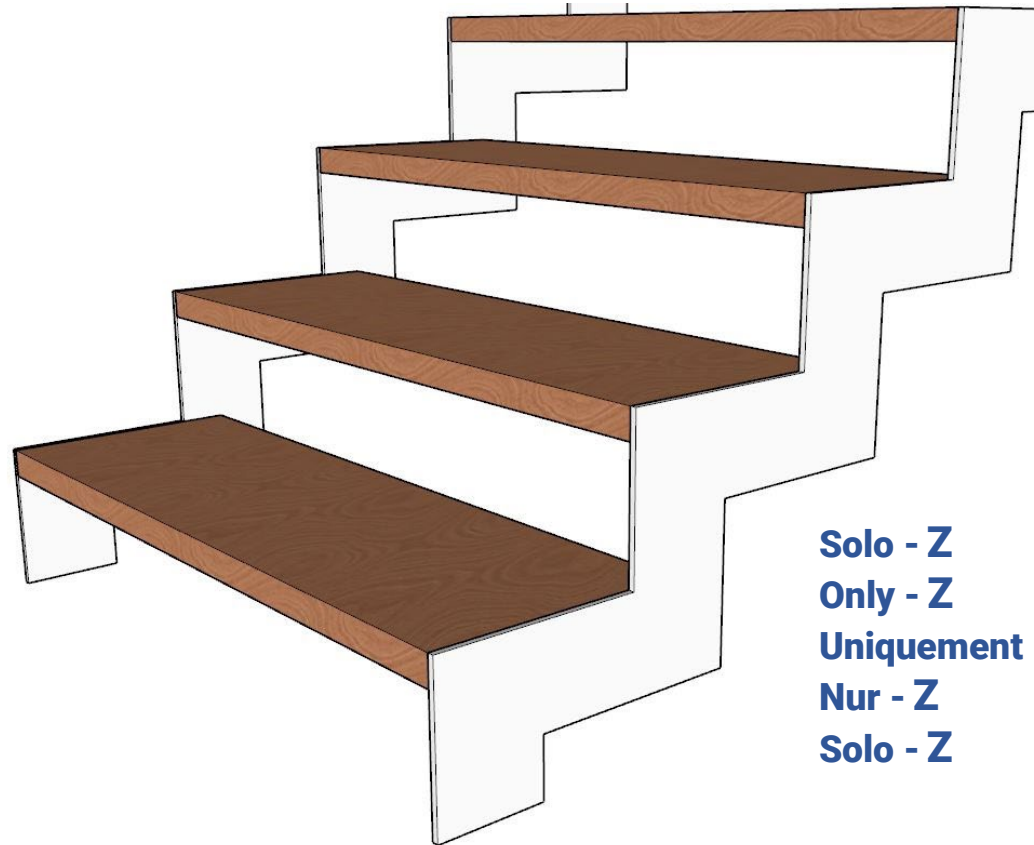

Solo - Z

Only - Z

Uniquement - Z

Nur - Z

Solo - Z

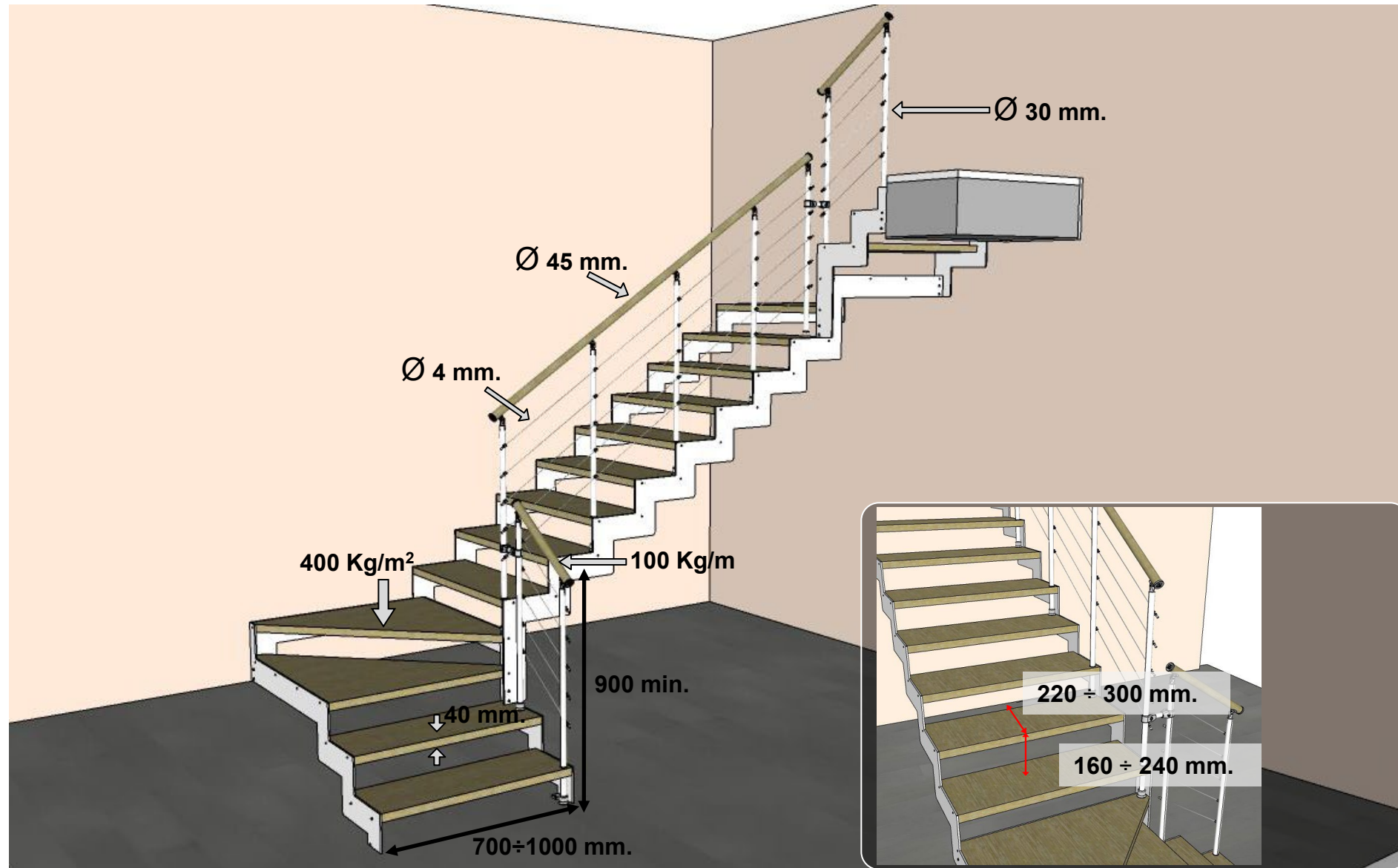

ARRIVO CON ALZATA
ARRIVAL WITH RISER
ARRIVÉ AVEC HAUTEUR
ANKUNFT MIT STEIGUNG
LLEGADA CON CONTRAHUELLA

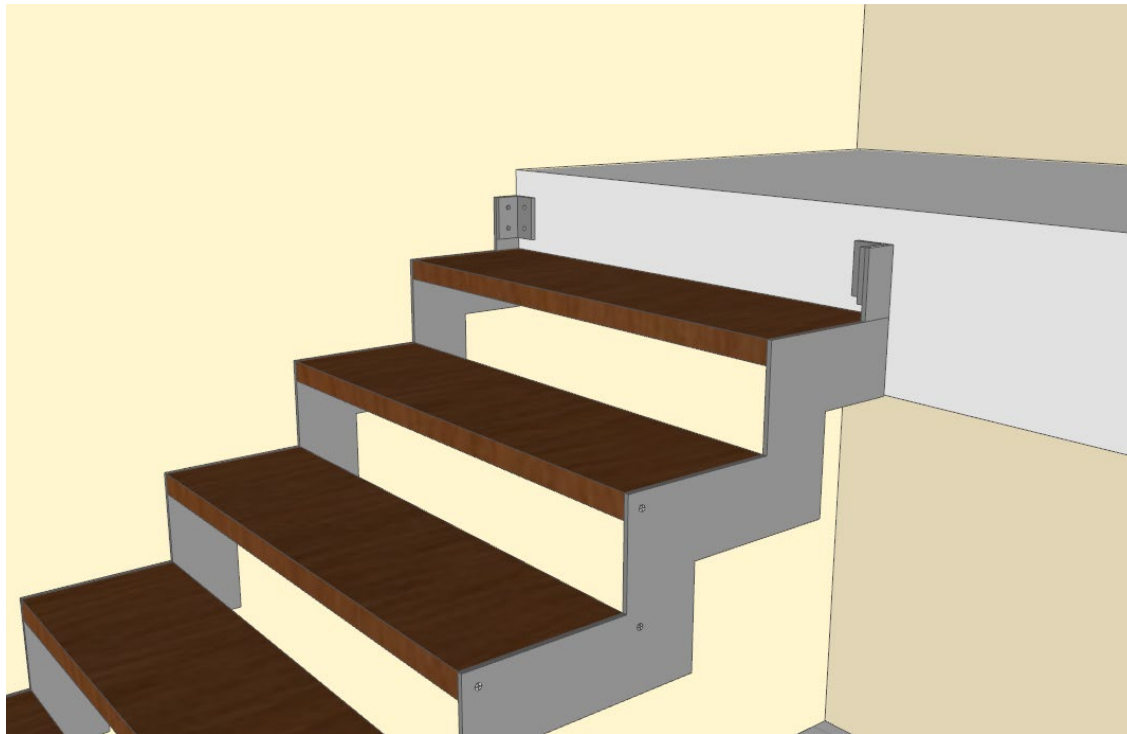

ARRIVO PARI PAVIMENTO
ARRIVAL AT SAME FLOOR LEVEL
ARRIVÉE AU MÊME NIVEAU DU SOL
ERREICHUNG GLEICHEN NIVEAU DES BODENS
LLEGADA MISMO NIVEL QUE EL SUELO

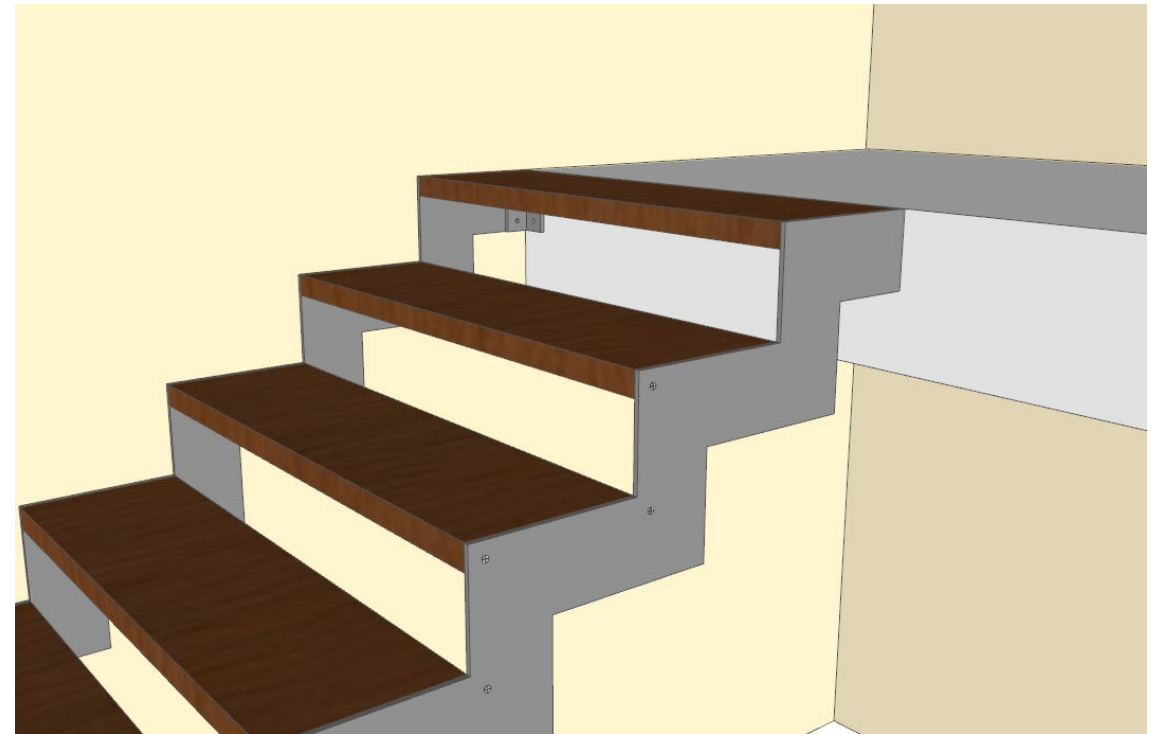

PARTENZA DA PAVIMENTO
FLOOR DEPARTURE - DÉPART DU SOL - ABGANG VOM
BODEN - SALIDA DESDE EL SUELO

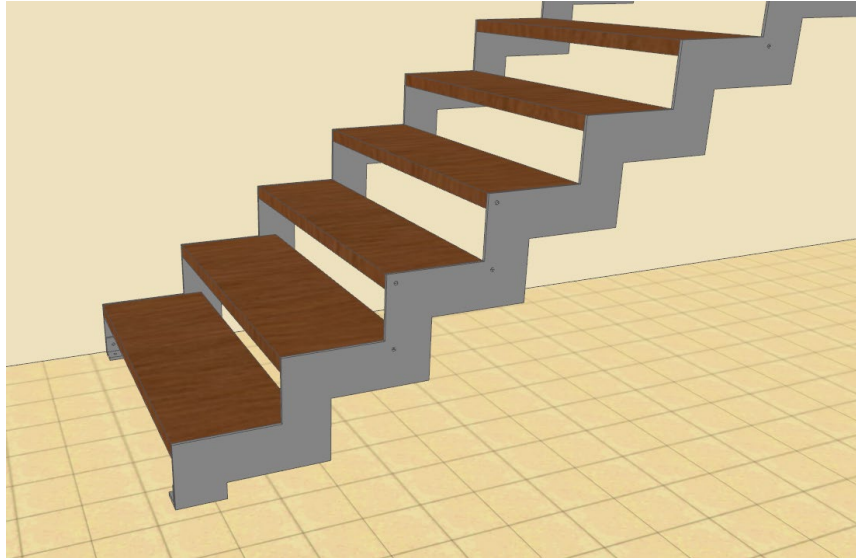

PARTENZA A SBALZO
CANTILEVER DEPARTURE - DÉMARRAGE EN PORTE-À-
FAUX - ÜBERHANGSTART - ARRANQUE EN VOLADIZO

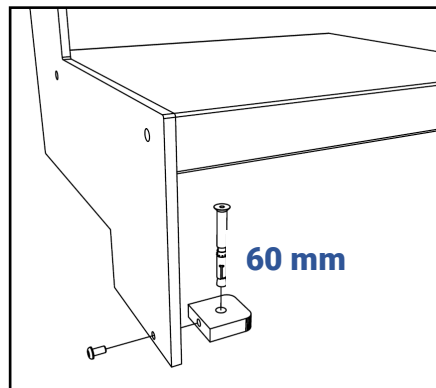
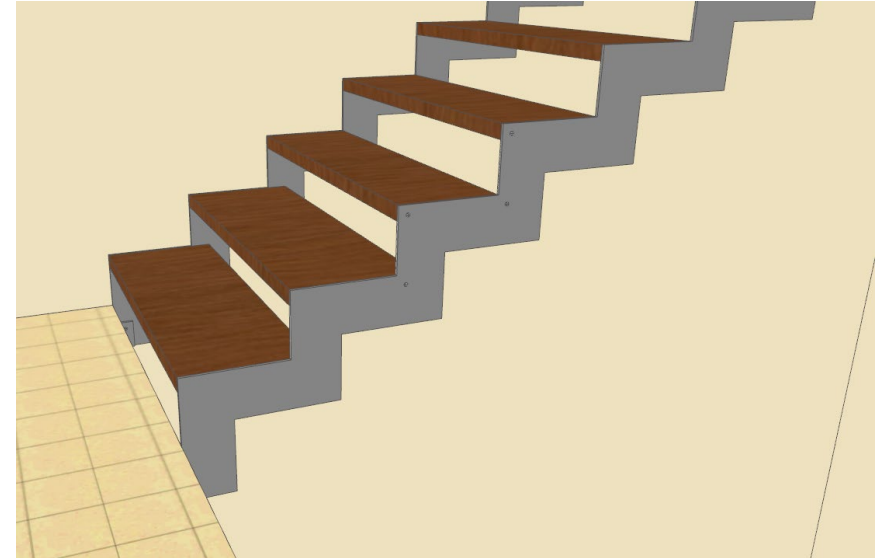

FISSAGGIO A PAVIMENTO
FLOOR FIXING
FIXATION AU SOL
BODENBEFESTIGUNG
FIJACIÓN DEL SUELO

BALAUSTRRE DISPONIBILI

Available Floor Protection Balustrade – Garde-corps étage disponibles –
Schutzgeländer verfügbar -Barandillas disponibles

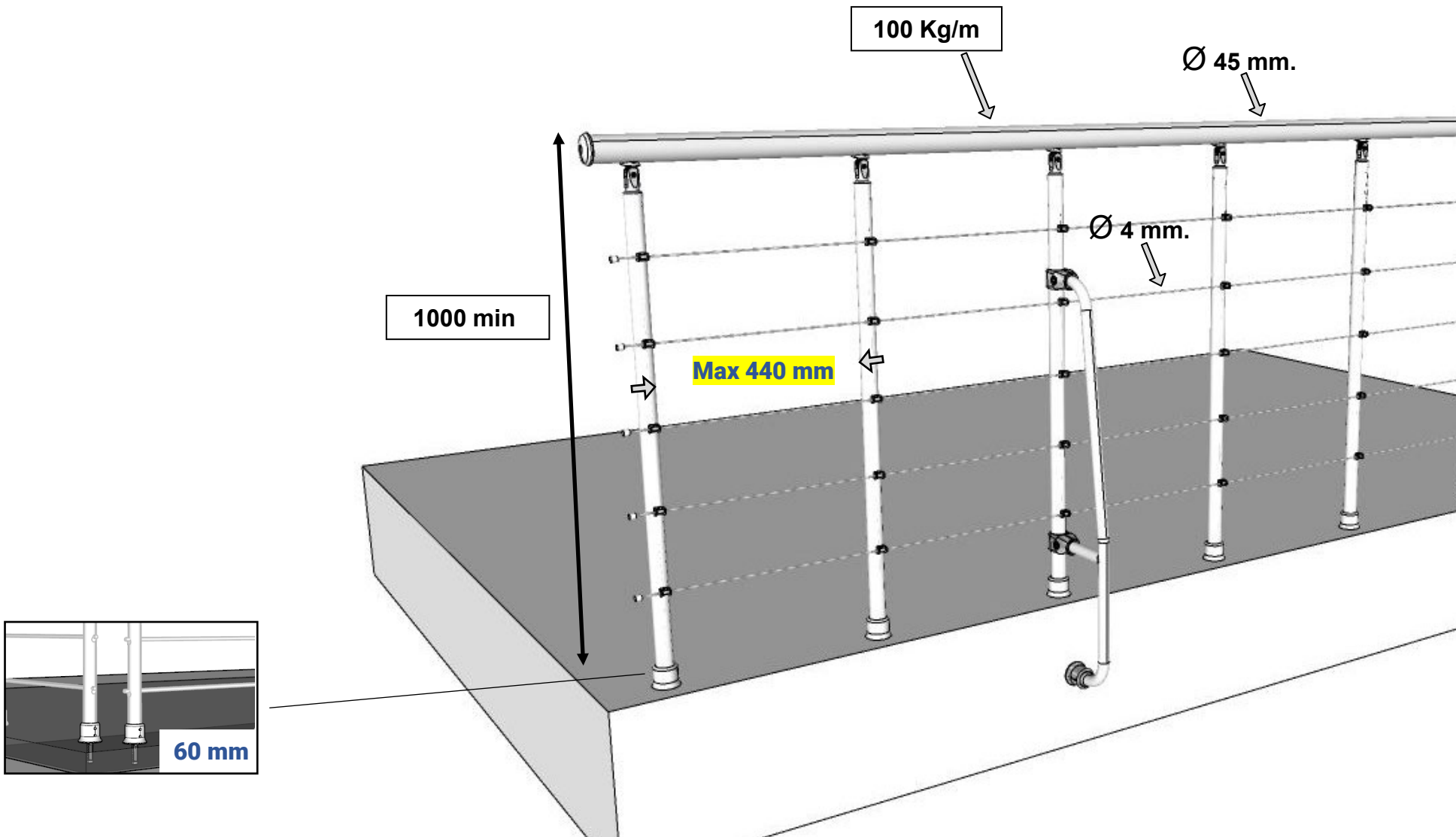

Alzate chiuse

Closed Risers – Contremarches
Setzstufen – Contrahuella cerrada

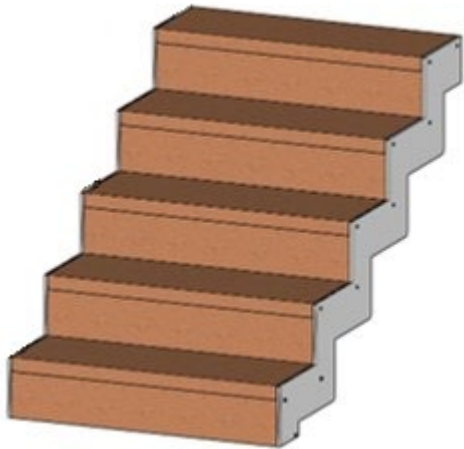

Angolo per pilastro (max 3 gradini)

Corner for Pillar (max 3 steps) – Angle pour Poteau (max 3 marches)
Winkel pro Säule (Max 3 Sufen) - Angulo por pilar (máximo 3 escalones)

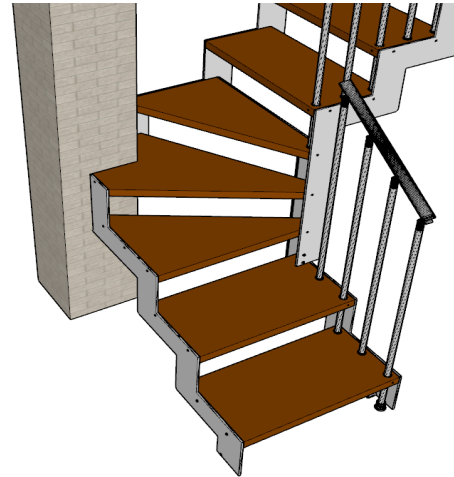

Struttura senza viti a vista

Structure with hidden screws – Structure avec vis cachées – Struktur mit versteckten schrauben – Estructura con tornillos ocultos

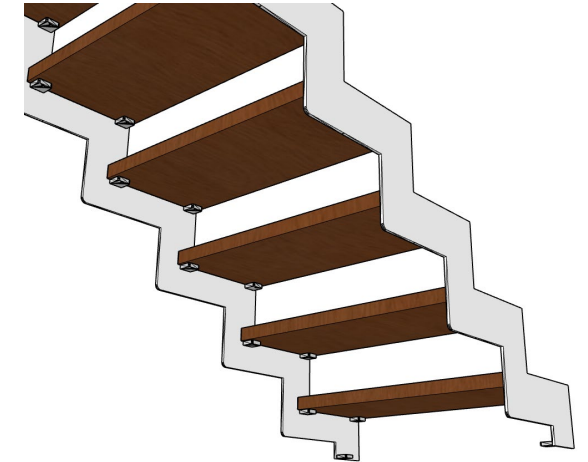

Corrimano a muro

Wall handrail – Main courante murale
Wandhandlauf - Pasamanos de pared

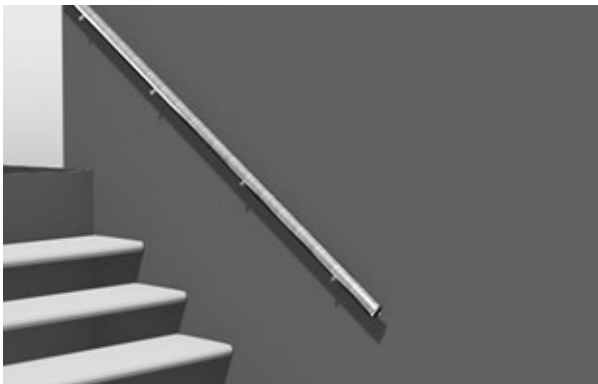

Soglia

Threshold – Seuil – Schwellenwert - Umbral

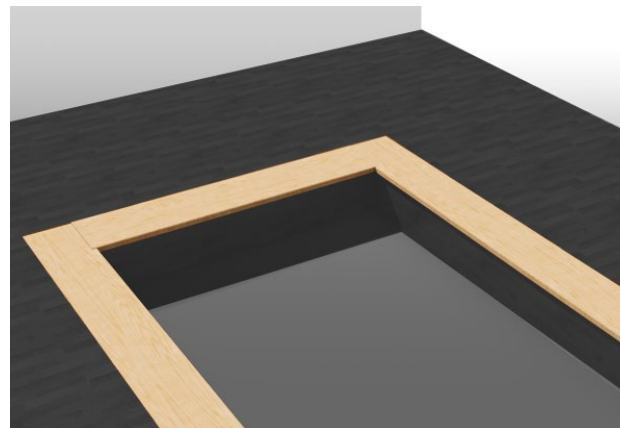

Scala fuori squadra

Out-of-square stair - Escalier hors équerre
Unregelmäßige Treppe – Escalera fuera de escuadra

